

Quadristar 900 BULK 40° B**Electrical Specifications**

Voltage	4 - 15V	
Bulkhead	any with 7/16-20 UNF thread, standard BH2MP is mounted	
Power	14W @ 12V	
Emitter	4 x Cree XP-G	
Driver	Multi-voltage 4 - 15V Microprocessor controlled PWM 100% and 50% dimmable Thermal protection Battery deep discharge protection 'Bring Me Home' mode	
Battery Burn Time	GFI I 12V 2.1Ah	100min
	GFI II 12V 4.5Ah	200min
	GFI III 12V 9Ah	400min

Material Specifications

Body	Aluminum AA6023 AlMgSiSnBi
Treatment	Black Hard anodization MIL-A-8625 Type III with Surlon MIL-A-63576 coating
Optics	High efficiency Polycarbonate
Front Lens	10mm BK7 glass
Depth rating	250 m, 26 BAR
Weight	195g

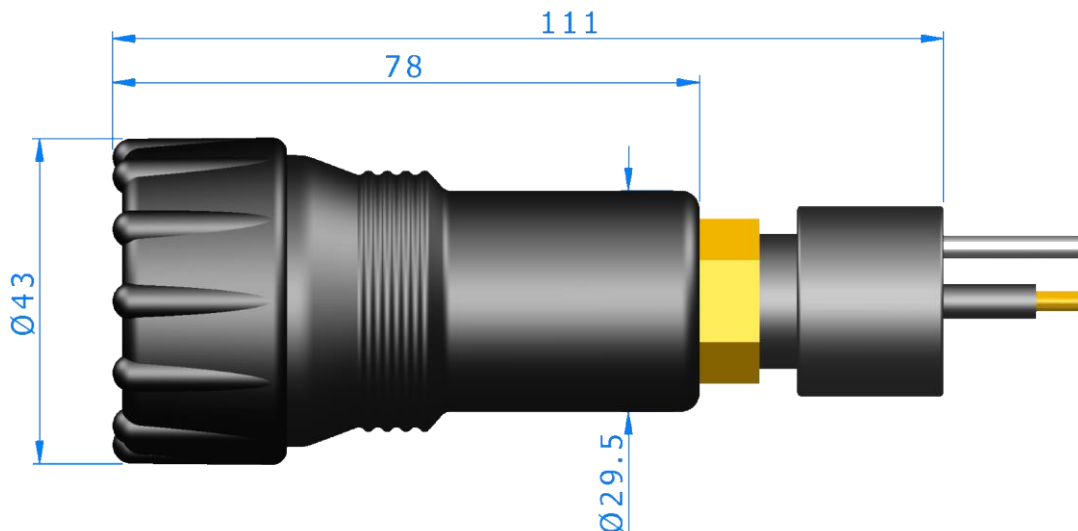

Optical Specifications

Luminous Flux	900 lumen @ 12V
Illuminance	1550 lux @ 1m
Beam Angle	40°
Color	5200K

Beamshot

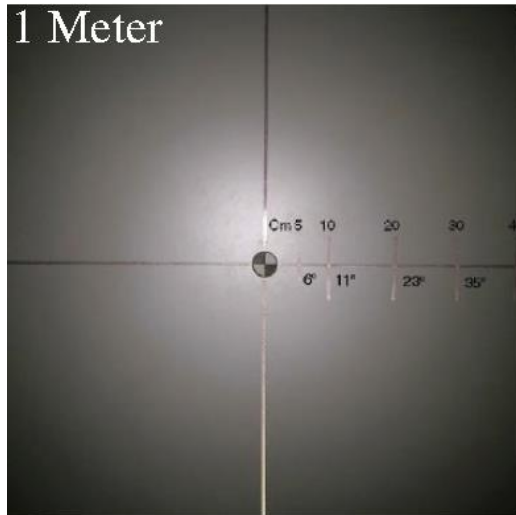

Spectro Metric Analysis

