

Quadristar 900 BULK 40° P**Electrical Specifications**

Voltage	8V (0%) - 13V (100%)
Bulkhead	any with 7/16-20 UNF thread, standard BH2MP is mounted
Power	14W @ full power
Emitter	4 x Cree XP-G
Driver	Microprocessor controlled PWM 0 - 100% linear dimming with GFI Dive Light Controller Thermal protection

Material Specifications

Body	Aluminum AA6023 AlMgSiSnBi
Treatment	Black Hard anodization MIL-A-8625 Type III with Surlon MIL-A-63576 coating
Optics	High efficiency Polycarbonate
Front Lens	10mm BK7 glass
Depth rating	250 m, 26 BAR
Weight	195g

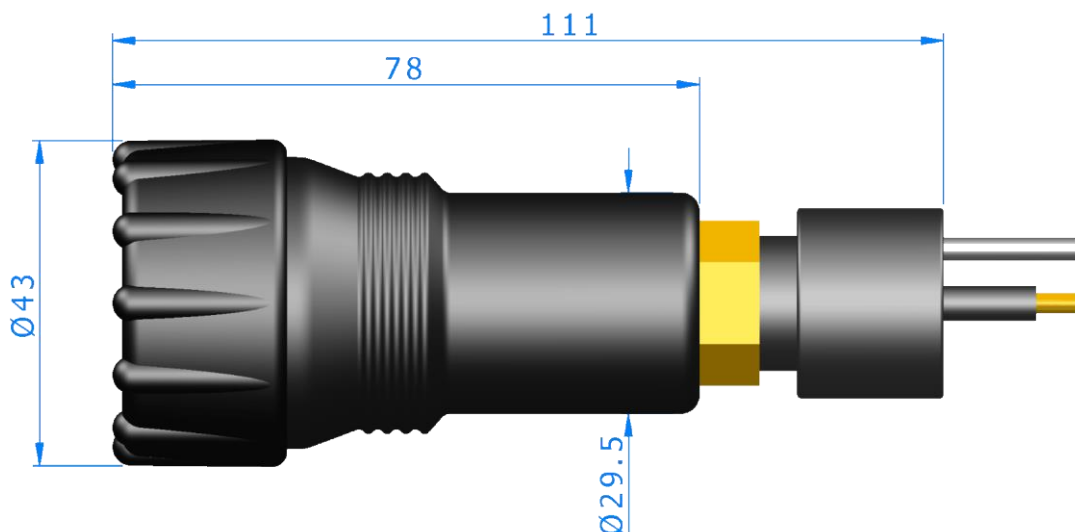

Optical Specifications

Luminous Flux	900 lumen @ 12V
Illuminance	1550 lux @ 1m
Beam Angle	10°
Color	5200K

Beamshot

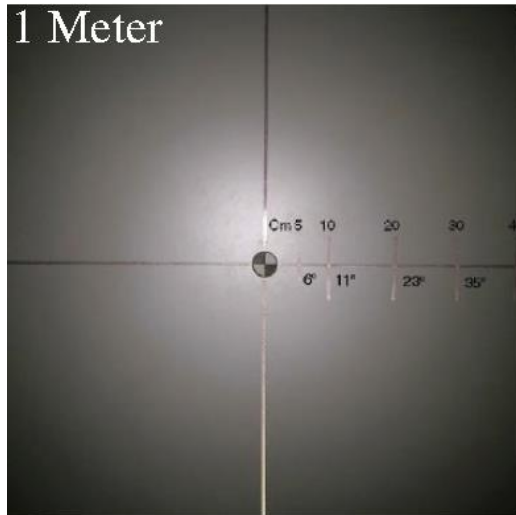

Spectro Metric Analysis

